

COMPUTHERM T7ORF

Programmable wireless (radio-frequency) digital room thermostat



Instruction Manual

GENERAL DISCRPTION OF THE THERMOSTAT

The **COMPUTHERM T7ORF** type switched-mode room thermostat is suitable to regulate the overwhelming majority of boilers and air conditioners available in Hungary. It can be easily connected to any gas boiler having a two-wire thermostat connection point and to any air conditioning apparatus or electrical apparatus, regardless of whether they have a 24 V or 230 V control circuit.

The thermostat can be programmed according to specific needs so that the heating (cooling) system heats (cools) your home or office to the desired temperature at the specified times specified, and it contributes to the reduction of energy costs, in addition to providing comfort. A daily temperature program can be prepared for each day of the week, independently of each other. It is possible to set comfort or economy temperature for each hour of the day separately.

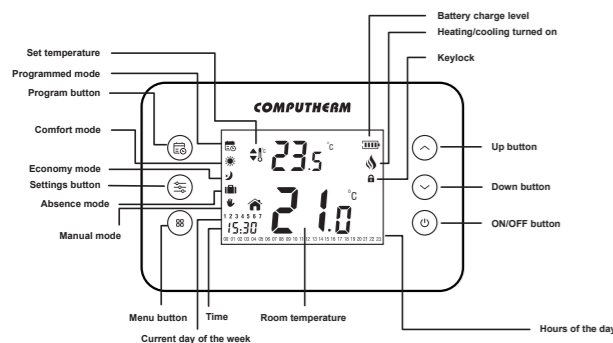

The device consists of two units. One of them is the portable control unit (thermostat), while the other unit is the receiver that controls the boiler. Because there is a wireless (radio-frequency) connection between the two units, no cable is required between the thermostat and the boiler.

The two units have been tuned in the factory. The trouble-free operation is ensured by its own security code. The installation and connection of the receiver unit is described in **Chapter 8**.

To increase the lifetime of the batteries, the thermostat will not transmit signals continuously. Instead it will repeatedly transmit the actual signal every 10 minutes. Therefore, the regulation of the heating or cooling will continue even after a blackout.

The portability of the thermostat offers the following advantages:

- no need to lay a cable, which is especially advantageous when old buildings are being modernized,
- the optimal location of the device can be selected during operation,
- it is also advantageous when you intend to locate the thermostat in different rooms in the course of the day (e.g. in the living room during the day but in the bedroom at night).

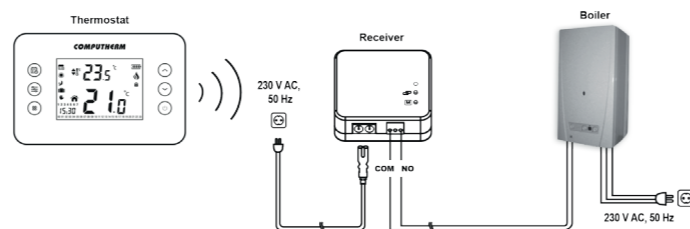

The effective range of the transmitter incorporated in the thermostat is approximately 100 m in open terrain. This distance may become considerably shorter within a building, especially when a metal structure, reinforced concrete or adobe wall stands in the way of radio waves.

The simultaneous use of several **COMPUTHERM** room thermostats and one **COMPUTHERM Q4** zone controller provides the possibility for the thermostats to also control a pump or a zone valve in addition to starting the heater or cooler. This way it is easy to divide a heating / cooling system into zones, thanks to which the heating / cooling of each room can be controlled separately, thus greatly increasing comfort. Furthermore, the zoning of the heating / cooling system will greatly contribute to the reduction of energy costs, as due to this only those rooms will be heated / cooled at any time where it is required.

1. LOCATION OF THE DEVICE

The thermostat of the **COMPUTHERM T7ORF** type device can be freely moved in your residence. It is reasonable to locate it in a room used regularly or for many hours per day so that it is in the direction of natural ventilation in the room but protected from drought or extreme heat (e.g. direct sunlight, refrigerator, chimney, etc). Do not use in wet, chemically aggressive or dusty environment. Its optimal location is 0.75 - 1.5 m above floor level. Can be placed on the holder or wall mounted.

IMPORTANT WARNING! If the radiator valves in your flat are equipped with a thermostatic head, adjust it to maximum temperature or replace the thermostatic head of the radiator valve with a manual control knob in the room where the room thermostat is to be located, otherwise the thermostatic head may disturb the temperature control of the flat.

2. INSTALLATION OF THE THERMOSTAT

2.1. Instert the batteries

To put the thermostat into service detach the wall-mounted supporting bracket from the thermostat then remove the battery compartment cover.

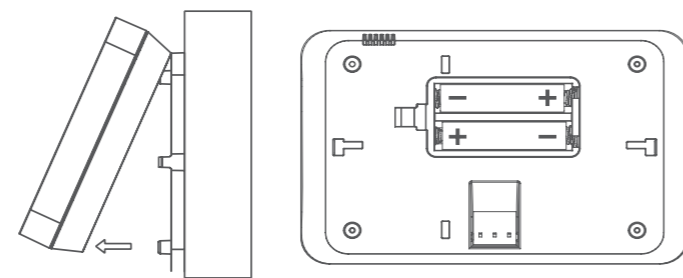

Insert the 2 alkaline batteries (AAA, type LR03) in the product box into the battery compartment according to the marked polarities.





Warning! Alkaline batteries may only be used for this appliance. Carbon-zinc batteries known as durable or long life batteries and chargeable accumulators are not suitable for the operation of this appliance. The  icon appearing on the display to indicate low battery voltage warns reliably that the batteries should be replaced only when alkaline batteries are used.

Attention! After the batteries have been replaced the exact time and day should be readjusted as described in **Chapter 2.3**. but the apparatus will memorize the other settings.









After the batteries have been installed, snap back the battery compartment cover and mount the thermostat, depending on the intended method of operation, onto its wall-mounted back panel or portable holder then press the  button located on the front panel once to turn ON the thermostat.





2.2. Operation of the key lock





Attention! The thermostat has an automatic key lock function to prevent accidental modifications of settings!





The  icon located on the right side of the display indicates that the key lock is turned on. To turn off the key lock, touch the  button for 3 seconds and the  icon disappears. Now you can freely use the touch keys of the thermostat until the automatic key lock is activated again. The key lock turns on 10 seconds after the last key has been touched, indicated by the appearance of the  icon on the display.

2.3. Setting the current day, exact time and temperatures used during the operation

Touch the  button for 3 seconds. Only the set time can be seen on the display of the thermostat, where the first two digits showing the hour are flashing and the digits of the minute are continuously visible. Using the  and  buttons, adjust the exact hour then touch the  button. Now the minute digits being set are flashing and the two digits indicating the hour are continuously visible. Using the  and  buttons, set the current minute value. Touch the  button again. Then the number indicating the set date appears on the display. Using the  and  buttons, set the current day (Monday: 1; Tuesday: 2; Wednesday: 3, etc.).





Touch the  button again. Now the  icon appears on the display with the set temperature next to it, which means the Comfort temperature. This temperature can be modified by touching the  and  buttons.

Touch the  button again. Now the  icon appears on the display with the set temperature next to it, which means the Economy temperature. This temperature can be modified by touching the  and  buttons.

Touch the  button again. Now the  icon appears on the display with the set temperature next to it, which means the Absence temperature. This temperature can be modified by touching the  and  buttons.

If you want to finish settings, confirm them by touching  button for 3 seconds or wait for 10 seconds. Then set data are recorded and the display of the apparatus returns to the main screen.

2.4. Calibrating the thermometer of the thermostat

You can calibrate the thermometer of the appliance (to correct measured temperature). To enter the calibration menu, in the OFF state of the thermostat, press and hold the  button for 2 seconds. Then the thermostat enters the calibration menu, the sign „CR.” and the set calibration temperature appear on the display which shows  by default. Then you can set the required temperature by means of buttons  and  in the range between -8 °C and +8 °C, in 0.5 °C increments. Following this, to save the setting and exit wait 10 seconds or press the  button three times. Now the thermostat is OFF and the setting will be activated when the thermostat is turned on again.

2.5. Switch between heating and cooling modes



You have the possibility to easily switch between heating (factory setting) and cooling modes.



The output terminals **NO** and **COM** of the thermostat are closed below the set temperature in heating mode, and they are closed above the set temperature in cooling mode (taking the switching sensitivity into account). The closed position of the **NO** and **COM** connection points of the output relay is indicated by the appearance of the  icon in the display of the apparatus both in heating and cooling modes.

2.6. Switch between heating and cooling modes

You have the possibility to easily switch between heating (factory setting) and cooling modes.

The output terminals **NO** and **COM** of the thermostat are closed below the set temperature in heating mode, and they are closed above the set temperature in cooling mode (taking the switching sensitivity into account). The closed position of the **NO** and **COM** connection points of the output relay is indicated by the appearance of the  icon in the display of the apparatus both in heating and cooling modes.







To enter the switching mode menu, in the  state of the thermostat, press and hold the  button for 2 seconds. Then the thermostat enters the calibration menu, the sign „CR.” and the set calibration temperature appear on the display. Now press the  button. Then the thermostat enters the menu used to switch between heating and cooling modes and signs „FU.” and



„HE.” (factory setting) appear on the display. You can switch between heating (HE) and cooling (CO) modes by using  and  buttons. Following this, to save the setting and exit wait 10 seconds or press the  button two times. Now the thermostat is OFF and the setting will be activated when the thermostat is turned on again.

3. OPERATING MODES OF THE THERMOSTAT





The thermostat can be used in 5 different modes which satisfy customers' needs.

Selectable modes

- a) **Programmed mode** (): controls heating/cooling according to the preset program
- b) **Comfort mode** (): heats/cool your home continuously to the preset comfort temperature
- c) **Economy mode** (): heats/cool your home continuously to the preset economy temperature
- d) **Absence mode** (): heats/cool your home continuously to the preset absence/vacation temperature
- e) **Manual mode** (): controls the heating/cooling system always according to the actual temperature set by the  and  buttons.

You can switch between modes by touching the  button. The manual mode can be activated in any operating mode, by touching the  or  buttons..

4. OPERATION OF THE INSTALLED THERMOSTAT

With the temperature adjustment buttons ( or ) of the thermostat you can set the desired temperature between 5 °C and 30 °C in 0.5 °C increments. The thermostat controls the device connected to it (e.g. gas boiler or pump) based on the measured and the currently set temperature, taking the switching sensitivity of the thermostat into account. This means that if the thermostat is in heating mode and set to 22 °C, then with the ±0.2 °C switching sensitivity the connection points **NO** and **COM** of the output relay are closed below 21.8 °C (heating is turned on) and opened at temperatures above 22.2 °C (heating is turned off). In cooling mode, the relay switches exactly the opposite way. On the other hand, after the temperature has been modified by the temperature adjustment buttons ( or ) of the thermostat the switching sensitivity is not taken into account therefore the thermostat will switch (turn off the heating) in case of ±0.1 °C temperature difference.

Depending on the change in the room and set temperature the thermostat controls (turns on or off) the heating/cooling system connected thereto. By default, the **NO** and **COM** contact pairs of the relay are open. The closed position of the **NO** and **COM** connection points of the output relay is indicated by the appearance of the  icon on the display of the apparatus both in heating and cooling modes.

To increase the lifetime of the batteries, the thermostat will not transmit signals continuously. Instead it will repeatedly transmit the actual signal every 10 minutes. Therefore, the regulation of the heating or cooling will continue even after a blackout.

5. PROGRAMMING THE THERMOSTAT







5.1. A brief introduction to programming

Programming means setting of switching times and the selection of temperature values (Comfort, Economy) assigned to them. The apparatus can be programmed for a period of one week. Its operation is automatic, repeating the preset switching process cyclically every seven days. The thermostat can be programmed for each hour of every day of the week separately, independently of each other. The preset Comfort or Economy temperature can be selected for each switching time. The temperature set for a given hour will remain valid until the start of the next hour, i.e. on a given day the temperature set for 11:00 a.m. will be maintained until noon, and the temperature set for noon will be maintained until 1:00 p.m. and so on.

Remark: Otherwise, from both a comfort and an energy-efficiency point of view, it is recommended to activate more than one switch for each day. Furthermore, it is advised that a comfort temperature is used only those times, when the room or building is in use, since every 1 °C decrease of temperature saves approximately 6% energy during a heating season.

5.2. Programming steps



- To enter programming mode touch the  button for 3 seconds. During the programming process the values to be set (day, hour, Comfort/Economy temperature) appear on the display of the apparatus.

- The **Comfort or Economy** temperature set beforehand can be assigned to every hour. Touching the  button you can switch between the two temperatures belonging to the hour concerned.
- By means of  and  buttons you can jog between hours within a given day. The actual hour appears, flashing at the bottom of the display. When jogging between hours the (**Comfort or Economy**) temperature selected for the hour being set will be saved. At the bottom of the display those hour numbers are indicated to which **Comfort** temperature is assigned, in case of **Economy** temperature the number of the hour concerned disappears after moving on.
- After preparing the entire program for a day you can set the next day after touching the  button or by touching the  button after the adjustment has been completed for 11:00 p.m.
- After you have prepared the program for every day according to your needs and you wish to finish programming, confirm the settings by touching the  button for 3 seconds. Then set data are recorded and the display of the apparatus returns to the main screen.

5.3. Recommendations for creating a heating program

The average comfort needs of a person can usually be satisfied by a temperature of 19-21 °C during the night, and a temperature of 22-23 °C during the day. During that time of the day, when the family is at work or school, only a lower temperature is needed. As heating up and cooling down usually takes a long time, it is reasonable to set the start time of the switches 0.5-1 hour before the desired time of the modified temperature. The programmability of the thermostat provides a perfect solution for this.







6. BATTERY REPLACEMENT

The average lifetime of the batteries is 1 year. The thermostat indicates battery charge level (e.g. ) on its display. The batteries should be replaced when the battery level icon on the display of the thermostat shows low charge level (). To replace the batteries, disconnect the thermostat from the wall mount bracket, then detach the battery cover. Insert 2 AAA **micro alkaline batteries** (LR03 type) in accordance with the diagram in the battery compartment. After the batteries have been replaced the temperature value should be readjusted because the apparatus returns to factory settings.

Warning! Alkaline batteries may only be used for this appliance. Carbon-zinc batteries known as durable or long life batteries and chargeable accumulators are not suitable for the operation of this appliance. The  icon appearing on the display to indicate low battery voltage warns reliably that the batteries should be replaced only when alkaline batteries are used.

7. RESETING THE THERMOSTAT TO ITS FACTORY DEFAULT SETTINGS

You can return all settings of the apparatus (set temperature [Comfort, Economy, Absence, Manual], set time, set date, weekly programming and calibration of thermostat) to their defaults.

To restore factory settings press the  button for 2 seconds in the OFF state of the thermostat. Then the thermostat enters the calibration menu, the sign „“ and the set calibration temperature appear on the display which shows  °C by default. Now press the  button twice. Then the thermostat enters the factory reset menu and the „“ sign appears on the display. To reset the thermostat to factory settings press the  button for 3 seconds. The thermostat switches off and its settings they are reset to factory defaults.

If you do not wish to restore factory settings wait 10 seconds or press the  button and the thermostat turns OFF. After the factory setting has been restored, perform base settings and programming of the apparatus as described in **Chapters 2** and **5**.

8. THE RECEIVER UNIT

WARNING! The device must be installed and connected by a qualified professional!

Before putting the thermostat into operation make sure that neither the receiver nor the apparatus to be connected to is not connected to the 230 V power network. Modifying the thermostat can cause electric shock or product failure.

8.1. Installation and connection of the receiver unit

The **COMPUTHERM T7ORF** thermostat receiver unit should be mounted on the wall in a place protected against moisture, dust, chemicals and heat, in the vicinity of the boiler. When choosing the location of the receiving unit you should remember that bulky metal objects (e.g. a boiler, buffer tank, etc.) and metal building structures may have an adverse effect on propagation of radio waves. If it is possible, in order to ensure trouble-free

RF connection, we recommend that you install the receiving unit at a height of 1.5 to 2 m and at a distance of 1 to 2 m from the boiler or other bulky metal constructions. We recommend that you check reliability of RF connection at the place selected before installing the receiving unit.

ATTENTION! Do not install the receiver unit under the housing of the boiler or near hot pipes because it may damage the parts of the device or compromise wireless (radio-frequency) connection. To avoid electric shock, entrust a specialist with connecting the receiver unit to the boiler!

You can mount the receiver onto the wall by means of the screws provided. 230 V supply voltage should be applied to the receiver, and the power cable required for this procedure is available in the box of the product. This ensures power supply to the receiving unit but this voltage does not appear at the output connection points. The power cable can be connected to the receiver in any position thereof, and it is not necessary to pay attention to correct phase alignment. Earth connection is not needed because the product is fitted with double insulation.

The receiver unit controls the boiler or air conditioner through a potential-free alternating relay whose connection points are: **NO**, **COM** and **NC**. Connect the two connection points of the heating or cooling equipment to be controlled to the normally open **NO** and **COM** terminals of the relay, as shown on the below figure.

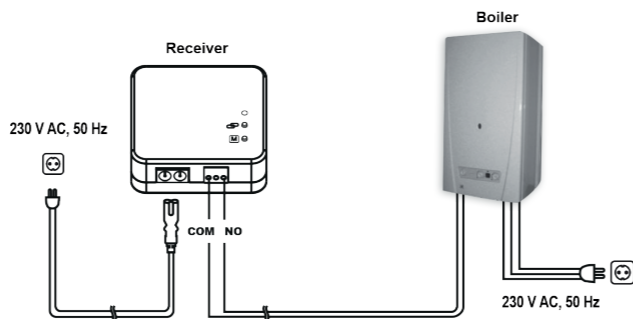

If you would like to operate an old boiler or any other device that has no connection points for thermostats, then the **NO** and **COM** connection points of the thermostat should be connected to the mains cable of the device, similarly as a switch would be connected.

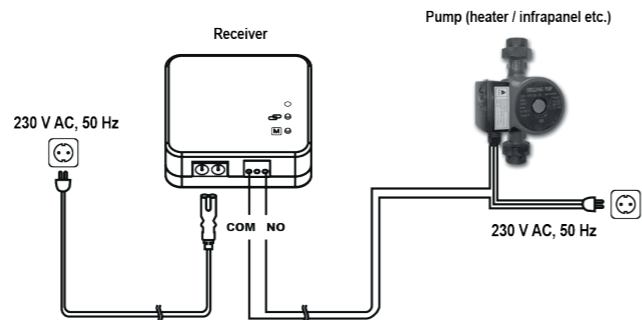



ATTENTION! Always consider the loadability of the receiver unit and follow the manufacturer's instructions of the heating or cooling equipment. The device must be installed and connected by a qualified professional!

The voltage appearing at terminals **NO** and **COM** depends only on the system being controlled, therefore the dimensions of the wire are determined by the type of the device to be controlled. The length of the wire is of no significance, the receiver unit may be installed either near the boiler or far away from it, but do not install it under the housing of the boiler.

If the distance between the transmitter and receiver units is too large due to local circumstances and it makes the wireless (radio-frequency) connection unreliable, install the receiver unit nearer to the place of thermostat.

8.2. Putting into service and operation of the receiver unit

Connect the receiver unit to the 230 V electricity network. After a few seconds have elapsed, the wireless (radio-frequency) system (thermostat and receiver unit) tunes itself to the operating frequency. To try the system in heating mode, press the  button of the thermostat several times, until the set temperature is higher than the temperature of the room. Following this, the  icon indicating that the heating is turned on should appear on the display of the thermostat within a few seconds. At the same time the orange LED on the receiver unit should flash three times then should light steadily, indicating that the receiver unit has received the signal coming from the transmitter (thermostat).









8.3. LED signals of the receiver

The operating condition of the receiving unit is indicated by a LED as detailed below:

- The green LED lights steadily: the receiver is tuned to the thermostat and functions properly.
- The green LED flashes 3 times: The receiver has received the signal of the thermostat, and according to the signal heating/cooling is not needed. Then the green LED lights steadily and the continuous lighting of the orange LED discontinues.
- The green LED is flashing continuously: The receiver is in tuning mode.
- The orange LED lights steadily: The thermostat gives heating/cooling command to the system connected thereto (closes **NO** and **COM** connection points).
- The orange LED flashes 3 times: The receiver has received the heating/cooling signal of the thermostat. Following this, the orange LED lights steadily.
- The orange and green LEDs are flashing continuously: The thermostat is working with manual control and gives a heating/cooling command to the system connected thereto (closes **NO** and **COM** connection points).
- The red LED is flashing continuously: The heating/cooling system has stopped because no switch signal arrived from the thermostat for more than 22 minutes.

8.4. Re-synchronization of the thermostat and the receiver unit

When the receiver fails to switch according to the switch signals of the thermostat while the location of the units is appropriate (see **Chapters 1** and **8.1.**) then the system needs to be retuned. To this end, the following steps should be performed:



- Press and hold the  button of the receiver for 2 seconds. Then the receiver is in tuning mode for 1 minute, and during this period the green LED is flashing.
- In the OFF state of the thermostat, press and hold the  button for 3 seconds. Then the thermostat enters the calibration menu, the sign „“ and the set calibration temperature appear on the display which shows  °C by default. Now press the  button of the thermostat briefly, and as a result the „“ sign representing the tuning mode appears for approximately 5 seconds.
- During this period press the  or  button of the thermostat to tune the two units.

In case of a successful tuning the receiver memorizes the security code of the thermostat which guarantees reliable and smooth operation of the two units. From then on the green LED on the receiver lights steadily, indicating normal operating conditions. The security code is not lost even in the event of a power failure and the connection will be re-established maximum 10 minutes after power supply to the receiver has been restored.

ATTENTION! Performing the steps of the tuning process on the thermostat generates a new security code which will be recognized by the receiver only after re-synchronization. With this in mind, do not repeat the steps of the tuning process on the thermostat without a reason after the two units have been tuned successfully.

If you accidentally press the button for 2 seconds and as a result the receiver enters the tuning mode then without a new tuning process the receiving unit will return to normal operations with the previous security codes after 1 minute has elapsed.

8.5. Manual control of the receiver unit

Pressing the  button for 2 seconds detaches the thermostat from the receiver and gives a heating/cooling command to the system connected thereto (closes **NO** and **COM** connection points), indicated by continuous flashing of the orange and green LEDs. In case of manual control the receiver does not receive the signals coming from the thermostat and gives a continuous heating/cooling command, regardless of the temperature set on the thermostat. By pressing the  button again for 2 seconds the receiver returns to the operation controlled by the thermostat.

FREQUENTLY ASKED QUESTIONS

When you think that your appliance is operating incorrectly or encounter any problem while the appliance is being used then we recommend that you read Frequently Asked Questions (FAQ) available on our website, where we collected the problems and questions that most frequently occur while our appliances are being used, along with the solutions thereto:

<http://www.computherm.info/en/faq>



The vast majority of the problems encountered can be solved easily by using the hints available on our website, without seeking professional help. If you have not found a solution to your problem, please pay a visit to our qualified service.

Warning! The manufacturer does not assume responsibility for any direct or indirect damages and loss of income occurring while the appliance is being used.

PRODUCT INFORMATION DATA SHEET:

- Trademark: **COMPUTHERM**
- Model identifier: **T7ORF**
- Temperature control class: **I. class**
- Contribution to the efficiency of seasonal space heating: **1%**

Remark:

In addition to using modern temperature regulators, the following up-to-date regulation methods also contribute significantly to the improvement of the comfort provided by the heating network, the energy efficiency of the heating network and the coefficient of performance:

- By dividing the heating network into sections or zones (e.g. by means of **COMPUTHERM Q4Z** zone controller and the associated **COMPUTHERM** zone valves) and with their separate regulation we can ensure that every room (zone) is heated only when it is necessary. (You can obtain information on the establishment of the heating network and apparatuses and fittings needed for division into zones in our publication titled „Energy Savings and Comfort“ which is also available on our website www.computherm.info/en).
- Using programmable thermostats you can ensure that every room (zone) is just heated according to a timetable preset in accordance with the demands. (You can obtain information on the services provided by **COMPUTHERM** programmable room thermostats on our website).
- Using modern modular heating devices equipped with an external temperature sensor the boiler can be operated at a higher efficiency.
- Using low temperature heating networks (e.g. 60/40 °C) and condensing boilers the temperature of the flue gas leaving the boiler can be reduced, and this way fuel efficiency can be improved significantly.

TECHNICAL DATA

— temperature measurement range:	-9.9 °C to +50 °C (in 0.1 °C increments)
— adjustable temperature range:	+5 °C to +30 °C (in 0.5 °C increments)
— temperature measurement accuracy:	±0.5 °C
— temperature calibration range:	±8.0 °C (in 0.5 °C increments)
— switching sensitivity:	±0.2 °C
— battery voltage:	2 x 1.5 V ALKALINE batteries (LR03 type; AAA size)

— battery lifetime:	approx. 1 year
— protection against environmental impacts:	IP20
— operating frequency:	433 MHz
— transmission distance:	approx. 100 m. in open terrain
— dimensions:	85 x 85 x 27.5 mm (without holder)
— weight:	151 g
— temperature sensor type:	NTC 3950 K 10 kΩ ±1% at 25 °C
— storage temperature:	-20 °C to +60 °C

Technical data of the receiver unit:

— power supply:	230 V AC, 50 Hz
— power consumption:	0.01 W
— switchable voltage:	max. 24 V DC / 240 V AC
— switchable current:	7 A (2 A inductive load)
— protection against environmental impacts:	IP30
— dimensions:	85 x 90 x 27.5 mm
— weight:	110 g

Total weight of the device: approx. 280 g (thermostat+receiver+holder)

The **COMPUTHERM T7ORF** type thermostat complies with the requirements of directives RED 2014/53/EU and RoHS 2011/65/EU.



Manufacturer:

QUANTRAX Ltd.

H-6726, Szeged, Fülemlé u. 34., Hungary
Phone: +36 62 424 133
Fax: +36 62 424 672
E-mail: iroda@quantrax.hu
Web: www.quantrax.hu • www.computherm.info
Turkey

Origin: